



# DVD-USB-SD CARD PLAYER



**MANUALE ISTRUZIONI**  
**INSTRUCTIONS MANUAL**  
**NOTICE DE MONTAGE ET D'EMPLOI**  
**GEBRAUCHSANWEISUNGEN**  
**MANUAL DE INSTRUCCIONES**

ITALIANO

ENGLISH

FRANÇAIS

DEUTSCH

ESPAÑOL

# VM072

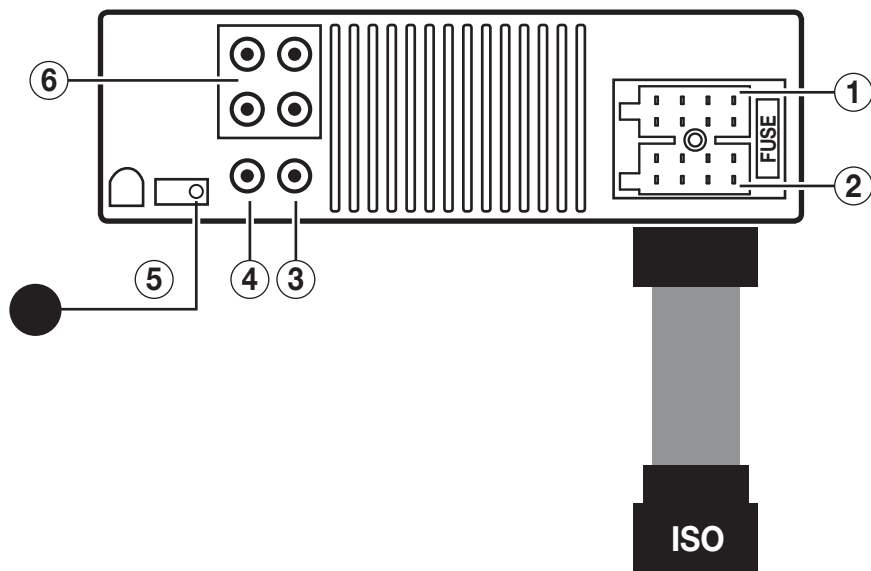

- |                          |                      |
|--------------------------|----------------------|
| 1. Alimentazione         | 1. Power             |
| 2. Uscita altoparlanti   | 2. Speakers output   |
| 3. Uscita video          | 3. Video output      |
| 4. Uscita Sub-Woofer     | 4. Sub-Woofer output |
| 5. IR Esterno            | 5. External IR       |
| 6. Uscite preamplificate | 6. Pre-amp output    |

## 1 ALIMENTAZIONE / POWER-SUPPLY

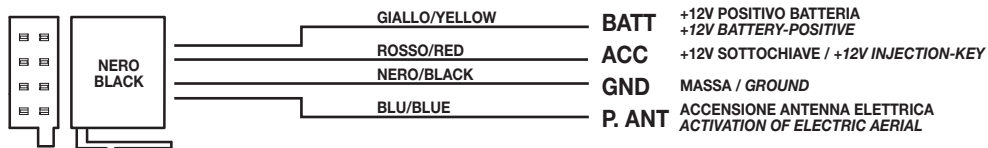

## 2 USCITE ALTOPARLANTI / SPEAKERS OUTPUT

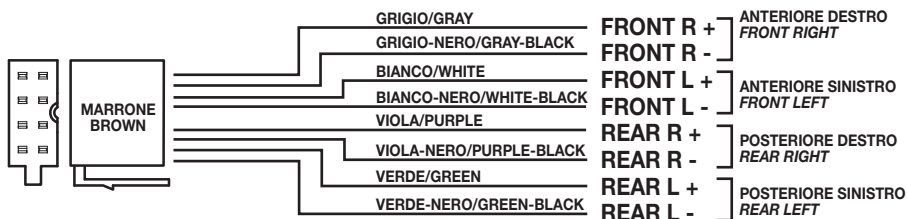

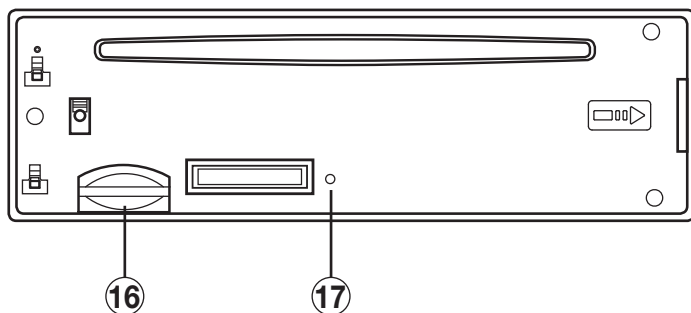

1. Espulsione disco
2. ⏮ ⏭ Traccia precedente / successiva
3. SRC Sorgente
4. DISCO / USB Selezione
5. Tasto sgancio frontalino
6. Accensione/Spegnimento ON/OFF
7. ▶⏸ Play / Pause / Intro
8. RPT / RDM Ripeti / Riproduzione casuale
9. Bilanciamento audio
10. DISPLAY/ MUTE Silenzia audio
11. Ingresso AUX-IN
12. Porta USB
13. Display
14. Feritoia disco
15. Controllo volume / Menù
16. Slot SD Card
17. Tasto impostazioni di fabbrica RESET

1. Disc eject
2. ⏮ ⏭ Previous / Next Track
3. SRC Source
4. DISC / USB Select
5. Release
6. Switch ON/OFF
7. ▶⏸ Play/Pause / Intro
8. RPT / RDM Repet / Random
9. BALANCE
10. DISPLAY/ MUTE
11. AUX-IN input
12. USB-port
13. Display
14. Disc slot
15. Volume adjustment / Menu
16. SD Card slot
17. Reset

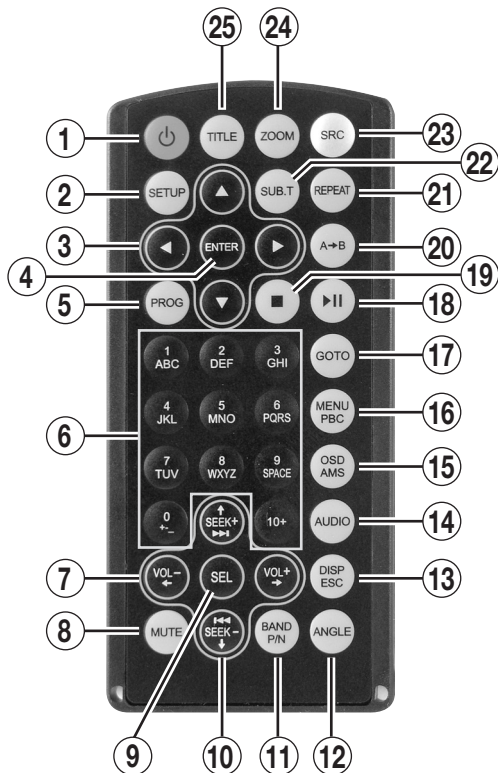

1. **POWER** Accensione/Spegnimento
2. **SETUP** Impostazioni generali
3. **◀▶▼▲** Tasti direzionali
4. **ENTER** Conferma
5. **PROG** Lista programmi
6. Tasti numerici
7. **VOL+ / VOL-** Regolazione volume
8. **MUTE** Volume azzerato
9. **NON ABILITATO**
10. **◀◀ ▶▶** Traccia precedente o successiva
11. **NON ABILITATO**
12. **NON ABILITATO**
13. **NON ABILITATO**
14. **AUDIO** Informazioni audio
15. **OSD/AMS** Informazioni riproduzione
16. **MENU PBC** Menù DVD
17. **GOTO** Selezione rapida traccia
18. **▶||** Riproduzione / Pausa
19. **■** Stop riproduzione
20. **A+B** Ripete capitolo
21. **REPEAT** Ripete traccia
22. **SUB.T.** Sottotitoli DVD
23. **SRC** Seleziona sorgente
24. **ZOOM** Regolazione
25. **NON ABILITATO**

1. **POWER** Switch-on/Switch-off
2. **SETUP**
3. **◀▶▼▲** Direction Keys
4. **ENTER** Confirmation
5. **PROG** Program list
6. Number-keys
7. **VOL+ / VOL-**
8. **MUTE**
9. **NOT AVAILABLE**
10. **◀◀ ▶▶** Previous/Next track
11. **NOT AVAILABLE**
12. **NOT AVAILABLE**
13. **NOT AVAILABLE**
14. **AUDIO** Audio info
15. **OSD/AMS** Track info
16. **MENU/PBC** Menù DVD
17. **GOTO**
18. **▶||** Playback/Pause
19. **■** Stop playback
20. **A+B** Chapter repeat
21. **REPEAT** Repeat track
22. **SUB.T.** DVD Subtitles
23. **SRC** Select Source
24. **ZOOM**
25. **NOT AVAILABLE**



Premere il tasto (SETUP) sul Telecomando.  
 Utilizzare i tasti ▼ / ▲ per posizionarsi sulla funzione desiderata e premere il tasto ENTER per confermare e SETUP per uscire.

*Press SETUP-key on the Remote-Control unit.  
 Use key ▼ / ▲ to move to the requested function. Now confirm selection by pressing ENTER. To quit, press SETUP-key.*

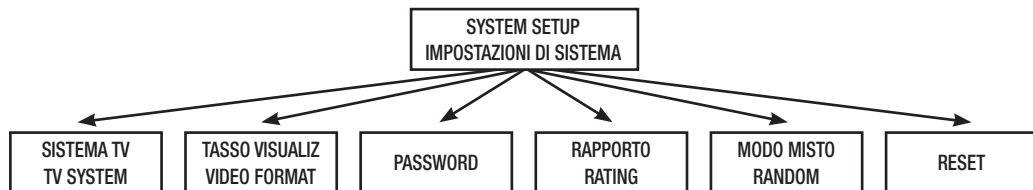

**MENU IMPOSTAZIONI 1**

Premere brevemente la manopola per accedere al menù impostazioni 1.  
 Premere brevemente la manopola per scorrere il menù e ruotarla per modificare i valori.

**SETTINGS MENU 1**

*Briefly press the knob for entering the settings menu 1.  
 Briefly press the knob for scrolling the menu and turn it, in order to change the values.*

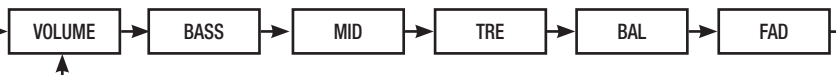

**MENU IMPOSTAZIONI 2**

Premere per 3 secondi la manopola per accedere al menù impostazioni 2.  
 Premere brevemente la manopola per scorrere il menù e ruotarla per modificare i valori.

**MENU SETTINGS 2**

*Press the knob for 3 sec. for entering the settings menu 2.  
 Briefly press the knob for scrolling the menu and turn it, in order to change the values.*



In assenza del disco, inserire il dispositivo USB/SD nell'apposita apertura. Il lettore cercherà automaticamente i file presenti sul supporto.

**Nota:** il funzionamento USB/SD è valido soltanto per la memoria volatile (flash). I formati compatibili sono: MP3, WMA, MPEG-4.

*Free from CDs, insert the USB/SD-support into the related Port. The Player will automatically search the files available on the related support.*

**Please note:** USB/SD-function works only referred to Flash-memory. Compatible Formats: MP3, WMA, MPEG-4.

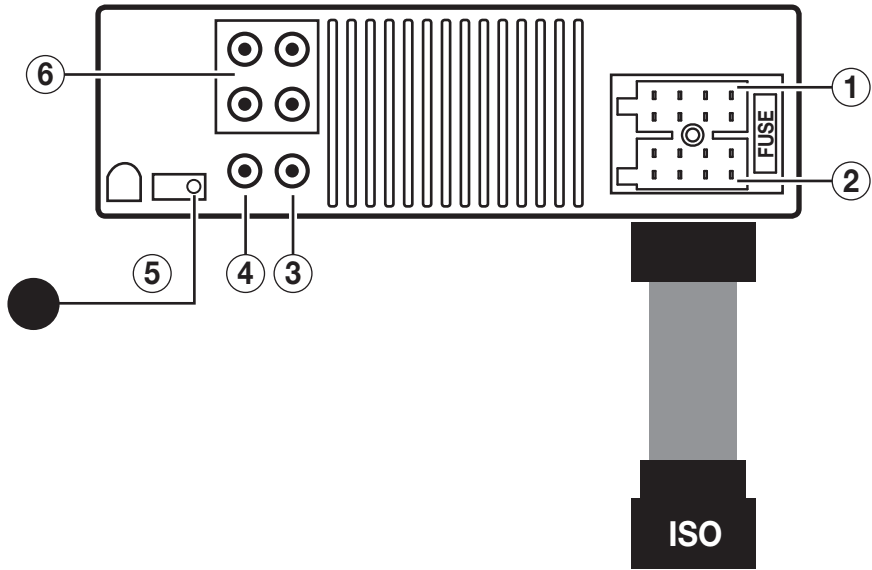

- |                          |                           |
|--------------------------|---------------------------|
| 1. Alimentation          | 1. Strom-zufuhr           |
| 2. Sortie hauts parleurs | 2. Lautsprechers ausgänge |
| 3. Sortie video          | 3. Ausgang Video          |
| 4. Sortie Sub-Woofer     | 4. Ausgang Sub-Woofer     |
| 5. IR Externe            | 5. IR Extern              |
| 6. Sortie Pre-ampl.      | 6. Ausgang Pre-amp        |

**1 ALIMENTATION / STROM-ZUFUHR**

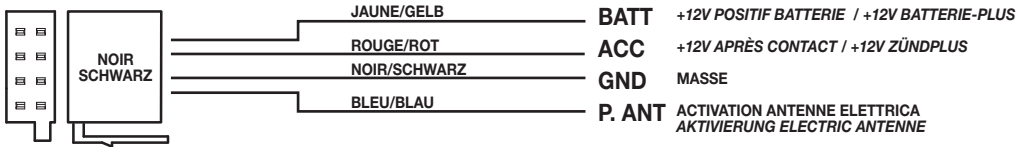

**2 SORTIE HAUTS PARLEURS / LAUTSPRECHERS AUSGÄNGE**

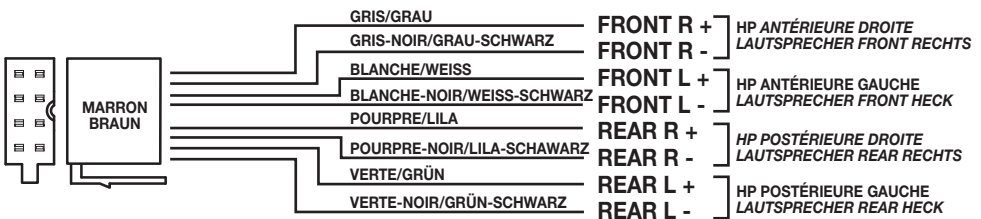

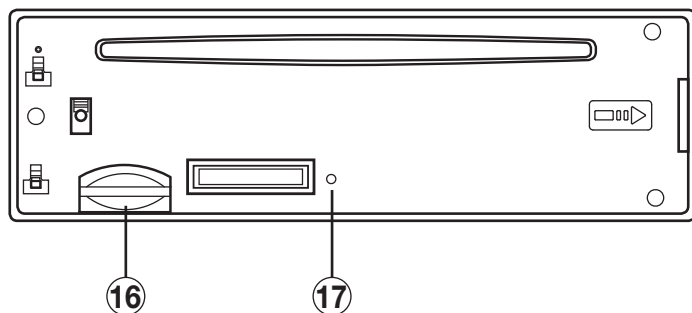

1. Expulsion du CD
2. ⏮ ⏭ Trace Précédente / Successive
3. SRC Source
4. DISCO / USB Sélection
5. Décroche la façade
6. Allumage / extinction ON / OFF
7. ▶|| Reproduction / Pause
8. RPT / RDM Répétition / Reproduction casuelle
9. Balance audio
10. Display/ Mute
11. Entrée AUX-IN
12. Port USB
13. Afficheur
14. Fente du disque
15. Réglage du volume / Menu
16. Slot SD Card
17. Touche RESET

1. CD-Auswurf
2. ⏮ ⏭ Stück davor / danach
3. SRC Quelle
4. DISCO / USB wählen
5. Bedienteil abnehmen
6. Ein-/Ausschalten ON/OFF
7. ▶|| Play/Pause
8. RPT / RDM Wiederhole / Wahllose Wiedergabe
9. Audio-Balance
10. Display/ Mute Stummschaltung (Mute)
11. AUX-IN-Eingang
12. USB-Öffnung
13. Display
14. CD-Öffnung
15. Volume / Menü Lautstärke-Regelung
16. SD-Öffnung
17. RESET-Taste



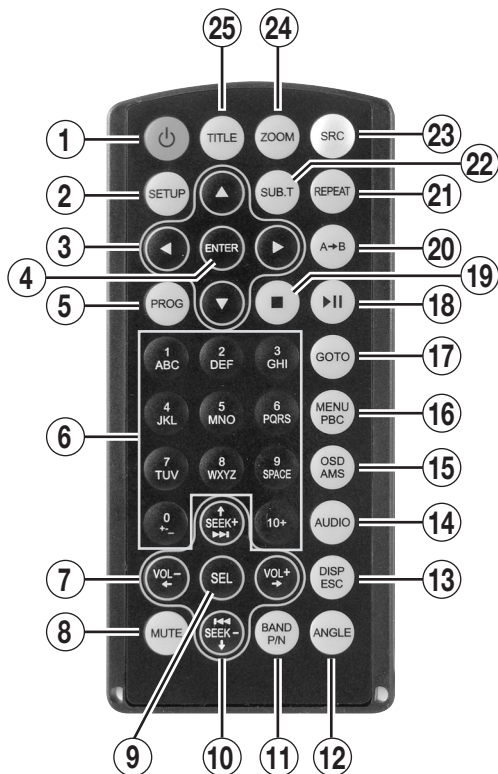

1. **POWER** Allumage / extinction
2. **SETUP**
3. ◀▶▼▲ Touches fléchées
4. **ENTER** Valide
5. **PROG** liste des programmes
6. Touches numériques
7. **VOL+ / VOL-** Réglages volume
8. **MUTE** Volume mis à zéro
9. **Pas disponible**
10. ◀◀▶▶ Trace Précédente/Successive
11. **Pas disponible**
12. **Pas disponible**
13. **Pas disponible**
14. **AUDIO** Informations audio
15. **OSD/AMS** Informations reproduction
16. **MENU PBC** Menu DVD
17. **GOTO**
18. ▶|| Reproduction/Pause
19. ■ Stop Reproduction
20. **A+B** Répétition Chapitres
21. **REPEAT**: Répétition trace
22. **SUBTITLE** Sous-titres **DVD**
23. **SRC** Sélectionne source
24. **ZOOM** Réglage
25. **Pas disponible**

1. **POWER** Einschalten/Ausschalten
2. **SETUP**
3. ◀▶▼▲ Pfeil-Tasten
4. **ENTER** = Bestätigung
5. **PROG**
6. Nummern-Tasten
7. **VOL+ / VOL-** Lautstärke-Regelung
8. **MUTE** Stummschaltung
9. **NICHT AKTIVIERT**
10. ◀◀▶▶ Stück davor / danach
11. **NICHT AKTIVIERT**
12. **NICHT AKTIVIERT**
13. **NICHT AKTIVIERT**
14. **AUDIO** Audio-Infos
15. **OSD/AMS** Wiedergabe-Infos
16. **MENU PBC** Menu DVD
17. **GOTO**
18. ▶|| Wiedergabe/ Pause
19. ■ Wiedergabe stoppen
20. **A+B** Kapitel Wiederholungen
21. **REPEAT** Stück wiederholen
22. **SUBTITLE** DVD-Untertitel
23. **SRC**: Quellen-Wahl
24. **ZOOM** Einstellung
25. **NICHT AKTIVIERT**



Appuyer la touche (SETUP) sur la télécommande  
 Se servir des touches ▼ / ▲ pour se placer sur la  
 fonction désirée et appuyer la touche ENTER pour  
 confirmer et SETUP pour sortir.

SET-UP-Taste auf der Fernbedienung drücken  
 Mit den Tasten ▼ / ▲ auf die gewünschte Funktion  
 gehen. Um die Wahl zu bestätigen, ENTER drücken.  
 Dann SETUP drücken, um Stellung wieder zu verlassen.

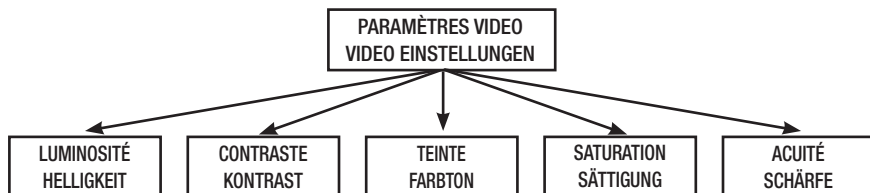
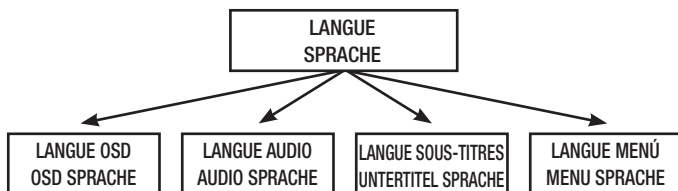
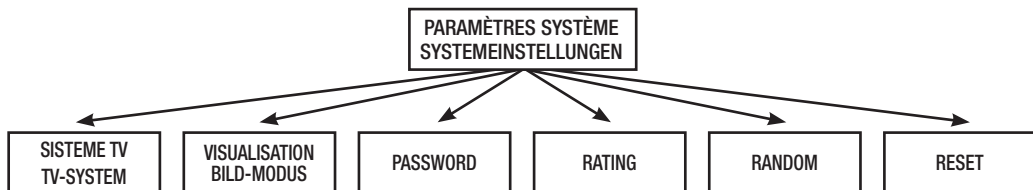

## MENU DES RÉGLAGES 1

Appuyer brièvement sur le bouton, pour accéder au menu des réglages 1.

Appuyer brièvement sur le bouton, pour parcourir le menu et tourner le bouton pour modifier les paramètres.

## MENÜ EINSTELLUNGEN 1

Den Knopf kurz drücken, um in das Menü der Einstellungen 1 zu gelangen.

Den Knopf kurz drücken, um das Menü zu scrollen. Dann den Knopf drehen, um die Parameter zu ändern.

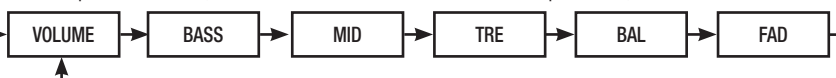

## MENU DES RÉGLAGES 2

Appuyer 3 secondes sur le bouton, pour accéder au menu des réglages 2.

Appuyer brièvement sur le bouton, pour parcourir le menu et tourner le bouton pour modifier les paramètres.

## MENÜ EINSTELLUNGEN 2

Den Knopf 3 Sekunden drücken, um in das Menü der Einstellungen 2 zu gelangen.

Den Knopf kurz drücken, um das Menü zu scrollen. Dann den Knopf drehen, um die Parameter zu ändern.



*Sans CD dans l'appareil, introduire le support USB/SD dans l'ouverture prévue. Le Lecteur cherchera automatiquement les Fichiers présents sur le support en question.*

**Note:** *le fonctionnement USB/SD est assuré uniquement pour la mémoire volatile (Flash).*

*CD aus dem Gerät entfernen. USB/SD in die vorgesehene Öffnung eingeben. Der Player wird nun automatisch die auf USB bzw. SD eingespeicherten Dateien suchen.*

**Wichtig:** *der USB/SD-Betrieb funktioniert nur begrenzt auf den Volatil-Speicher (Flash memory).*

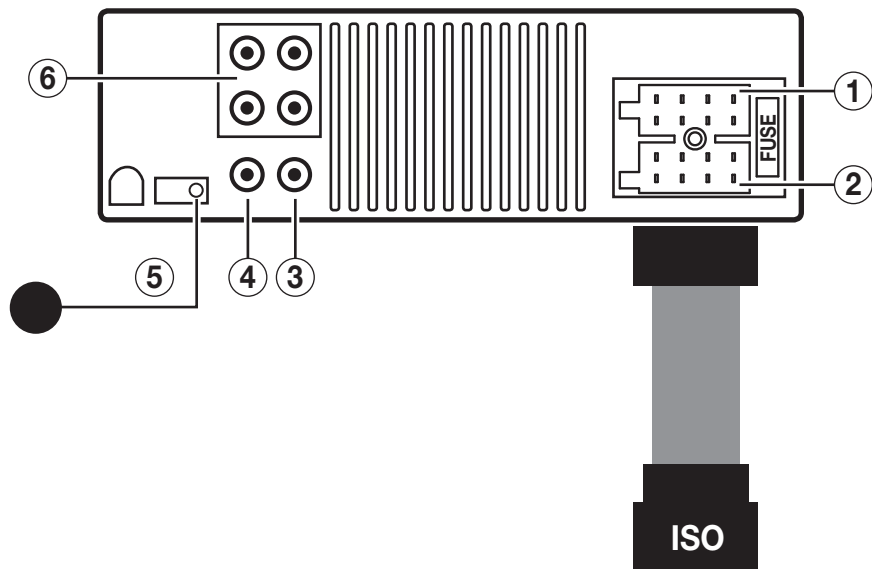

- 1. Alimentación
- 2. Salida altavoces
- 3. Salida video
- 4. Salida Sub-Woofer
- 5. IR Externo
- 6. Salida Pre-amp

## 1 ALIMENTACION



## 2 SALIDA ALTAVOCES



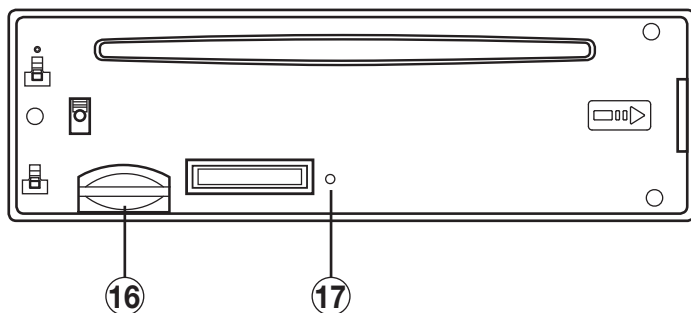

1. Expulsión disco
2. ◀▶ Pista precedente / siguiente
3. SRC Selecciona fuente
4. DISCO/USB Selección
5. Desengancha la caratula
6. Encendido /Apagado
7. ▶|| Reproducción / Pausa / Intro
8. RPT / RDM Repetición / Reproducción casual
9. Balance Audio
10. Display/ Mute
11. Entrada AUX-IN
12. Puerto USB
13. Display
14. Ranura disco
15. Volumen / Menu
16. Ranura SD Tarjeta de memoria
17. Tecla RESET

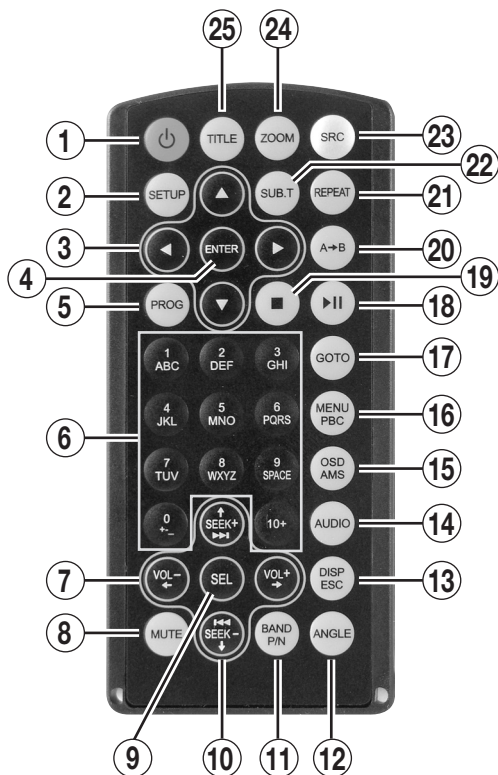

1. **POWER** Encendido/Apagado
2. **SETUP**
3. ◀▶▲ Teclas de flecha
4. **ENTER** = Confirmar
5. **PROG**
6. Teclas numéricas
7. **VOL+ / VOL-** Ajuste del volumen
8. **MUTE** Volumen 0
9. **No habil**
10. |◀◀▶▶| Pista Precedente/Siguiente
11. **No habil**
12. **No habil**
13. **No habil**
14. **AUDIO** Información audio
15. **OSD/AMS** Información reproducción
16. **MENU PBC** Menu DVD
17. **GOTO**
18. ▶|| Reproducción / Pausa
19. ■ Stop reproducción
20. **A+B** Repetición capítulos
21. **REPEAT** Repetición pistas
22. **SUBTITLE** Subtítulos **DVD**
23. **SRC** Selección fuente
24. **ZOOM** Ajuste
25. **No habil**

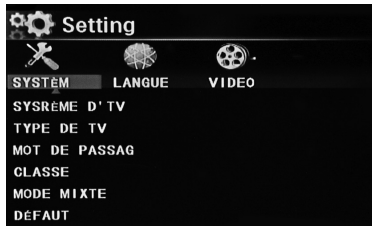

Presionar la tecla (SETUP) en el mando a distancia.  
Utilizar las teclas ▼ / ▲ para posicionarse en la función deseada y presionar la tecla ENTER para confirmar SETUP para salir.

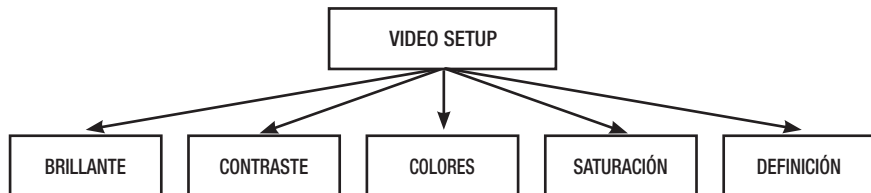
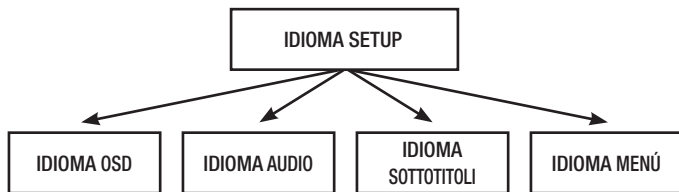
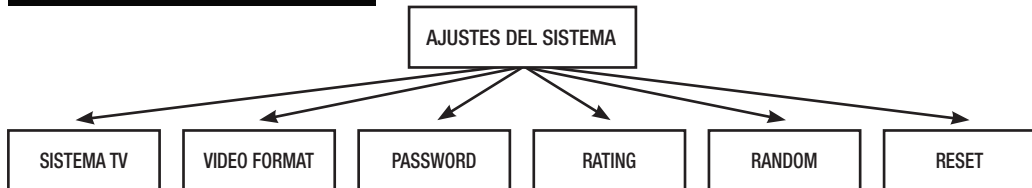

## MENÚ AJUSTES 1

Pulsar brevemente el mando del volumen para acceder al menú de ajustes 1.  
Pulsar brevemente el mando para ver las funciones y girar el mismo para modificar los valores.

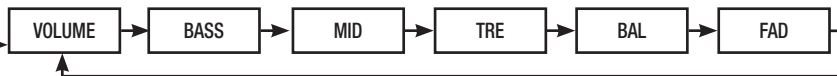

## MENÚ AJUSTES 2

Pulsar durante 3 segundos el mando para acceder al menú de ajustes 2.  
Pulsar brevemente el mando para ver las funciones y girar el mismo para modificar los valores.



## USB-SD card

En ausencia del disco, introducir el dispositivo USB/SD en el específico puerto o correspondiente ranura. El reproductor buscará automáticamente los archivos presentes en el soporte.

**Nota:** el funcionamiento USB/SD es válido solo para la memoria volátil (flash). Los formatos compatibles son: MP3, WMA, MPEG-4.

**Caratteristiche tecniche • Technical specifications**  
**Caracteristiques techniques • Technische daten**  
**Caracteristicas tecnicas**

- **Sistema colore / Colour System** NTSC/PAL
- **Formati visualizzazione / Conforming format to** 16:9 – 4:3 letter box
- **Visualizzazione DVD multiangolo / Multi angle DVD vision**
- **Menù, sottotitoli e audio multilingua / Multilanguage Menu, subtitles and audio**
- **Memorizzazione ultima posizione / Last position memory**
- **Equalizzatore 4 bande / 4-band Equalizer** (Classic, pop, rock, flat)
- **6 Velocità di scansione / 6 scan speeds**
- **Meccanica anti-urto / Anti shock housing**
- **Protezione elettronica contro gli urti / Electronic shock protection system**
- **1 Porta USB anteriore / 1 USB Front input**
- **1 Slot SD/MMC card / 1 Front SD/MMC card slot**
- **1 Ingresso aux-in anteriore / 1 Front aux-in input**
- **Potenza 4x40W MAX/ 4x40W MAX high power amplifier**
- **1 Uscita audio stereo 2 Volt / 1 Stereo audio output 2 Volt**
- **1 Uscita video / 1 Video output**
- **Ricevitore IR / IR Sensor**
- **Telecomando con tutte le funzioni / Remote Control with full Functions range**
- **Alimentazione / Power** 12 V



ISO



10R - 053672